

شركة الفهد
للتجارة والصناعة والمقاولات
فرع المنتجات الإنشائية



ففي خدمة الوطن



Introduction:-

Al-Fahd Company Trading Industries and Contracting (ISO Certified) was established in 1968 in Onaizah Al Qassim, Saudi Arabia. The company has expanded and developed as diversified project that meets some of the requirements of the Saudi market through four main sectors, Contracting, Real Estate Investment, Industry and Trading.

Since it's established the company worked on developing its business and providing high quality products in fields of ready mixed concrete, asphalt mixture, different types of tiles & blocks, prefabricated ceilings and Al-Fahd future houses.

We have also developed the production of chemically treated interlock tiles to prevent the penetration of salts to the surface of the tiles and preventing the leakage into it.

Al Fahd Company continues its capabilities to develop to the better to meet the challenges of the vision of 2030.

مقدمة :-

تأسست شركة الفهد للتجارة والصناعة والمقاولات عام ١٩٦٨ ومقرها الرئيسي بعنيزة منطقة القصيم ولها فروع أخرى عاملة وحاصلة على شهادة ISO وقد نشأت الشركة كمشروع متنوع يلبي جزء من متطلبات وحاجات السوق السعودي وذلك من خلال أربعة قطاعات محورية وهي المقاولات والاستثمار العقاري والصناعة والتجارة.

وقد عملت الشركة على تطوير أعمالها ومنتجاتها لتقديم منتجات عالية الجودة بأقل تكلفة وذلك في مجال

الخرسانة الجاهزة والخلطات الأسفلتية و البلاط والبلوك بأنواعهم المختلفة و الأسقف الجاهزة والبيوت الجاهزة.

كما أننا طورنا البلاط المتداخل حيث يتم معالجة المنتج كيميائياً وذلك لمنع نفاذ الأملاح لسطح البلاط ومنع تسرب المواد إلى داخله.

كما أن الشركة سوف تستمر في تطوير منتجاتها لتتوافق مع رؤية المملكة ٢٠٣٠.

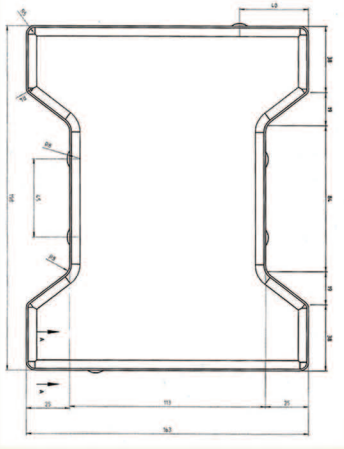

Dimension: 163 x 198 mm
Thickness: 60 mm
Weight: 3.7 kg
Area: 24161 mm²
M²/Piece: 36 Pcs

معالج كيميائياً

Chemically Treated

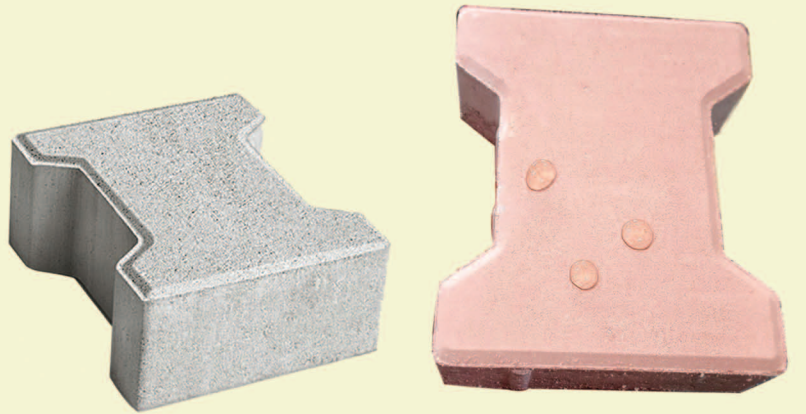
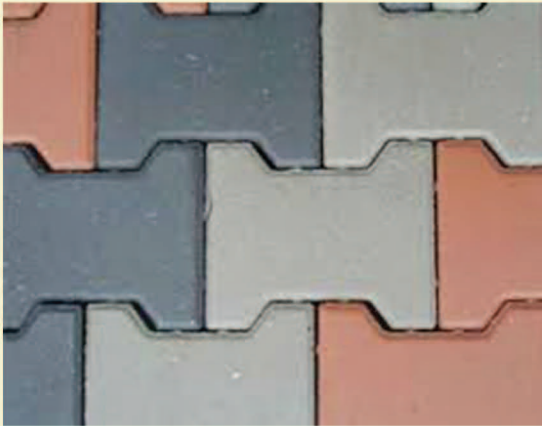

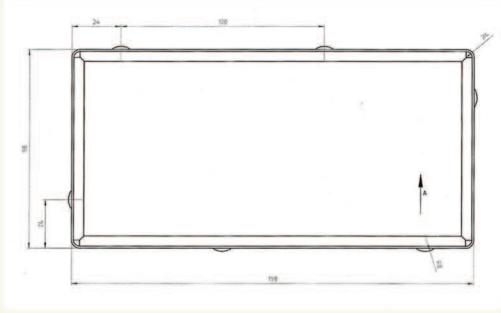

Dimension: 100 x 200 mm

Thickness: 60 mm

Weight: 2.6 kg

Area: 20000 mm²

M²/Piece: 50 Pcs



Chemically Treated
معالج كيميائيا

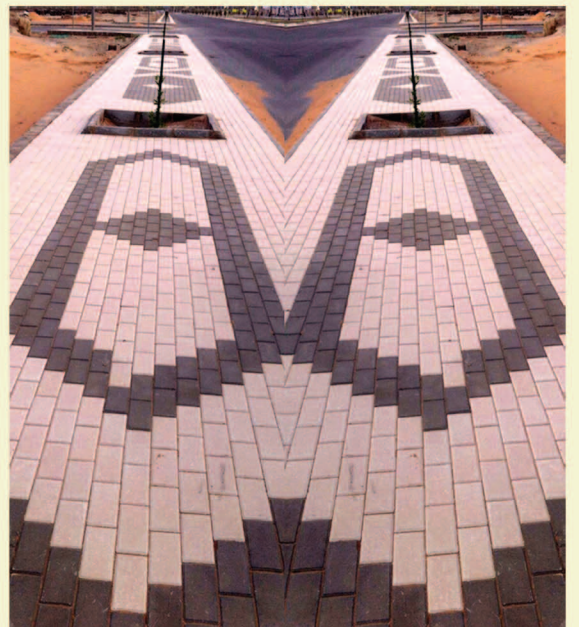

INTERLOCK

مقاسات ومساحات البلاط المتداخل

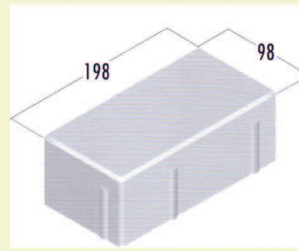

Holland
Dimension: 100 x 200 mm
Thickness: 60 mm
Weight: 2.6 kg
Area: 20000 mm²
M²/Piece: 50 Pcs

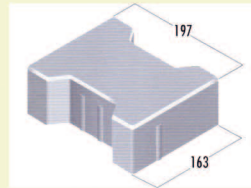

Behatton
Dimension: 163 x 198 mm
Thickness: 60 mm
Weight: 3.7 kg
Area: 24161 mm²
M²/Piece: 36 Pcs

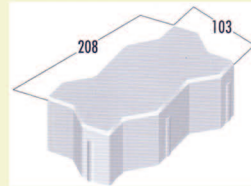

Uni
Dimension: 328 x 127 mm
Thickness: 60 mm
Weight: 3.3 kg
M²/Piece: 41 Pcs

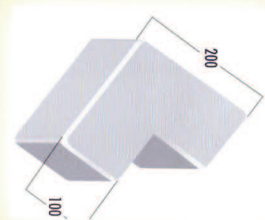
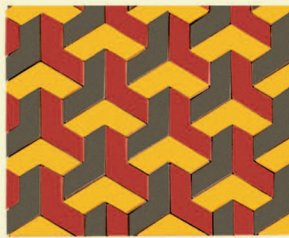

3D
Dimension: 200 x 146.5 mm
Thickness: 60 mm
Weight: 2.6 kg
M²/Piece: 39 Pcs

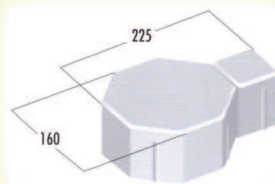
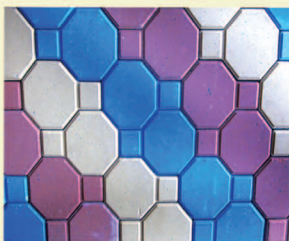

Octa Decor
Dimension: 160 x 225 mm
Thickness: 60 mm
Weight: 2.9 kg
M²/Piece: 40 Pcs

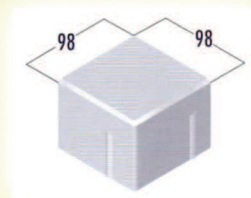
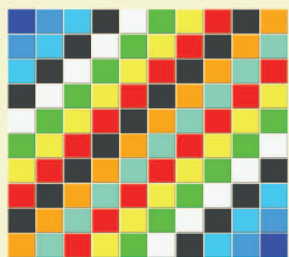

Holland
Dimension: 100 x 100 mm
Thickness: 60 - 80 mm
Weight: 1.3- 1.8 kg
M²/Piece: 100 Pcs

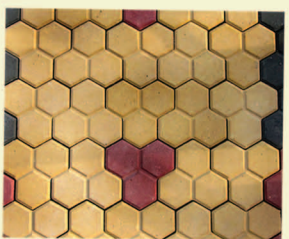

Delta
Dimension: 200 x 200 mm
Thickness: 60 mm
Weight: 2.7 kg
M²/Piece: 38 Pcs

مميزات المنتج :-

- سهولة استخدامه مع إمكانية إعادة استعماله أكثر من مرة.
- أقل تكلفة من المنتجات الأخرى قياساً لعمره و إستمراريته لفترات طويلة.
- تنوع في الأشكال و الألوان.

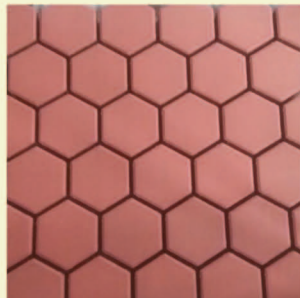
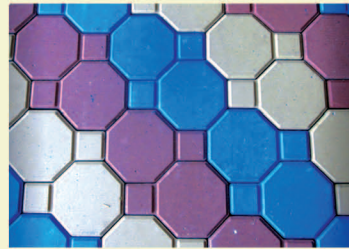
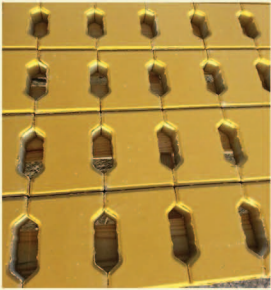

OCTA

أوكتا

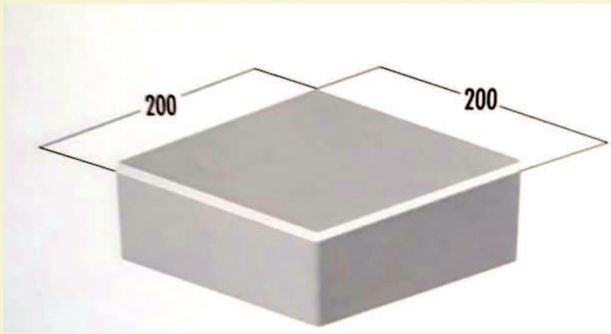

Dimension: 200 x 200 mm
Thickness: 60 mm
Weight: 3.70 kg
M²/Piece: 28Pcs

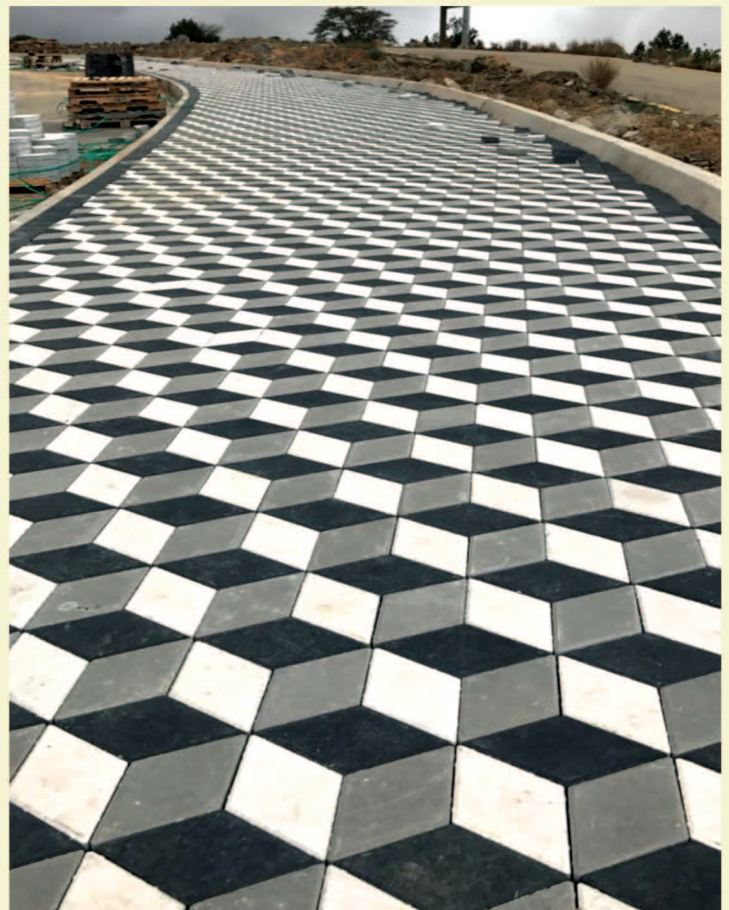
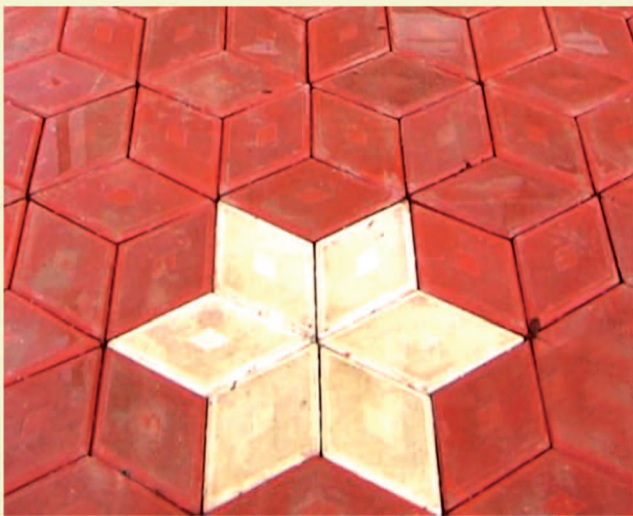
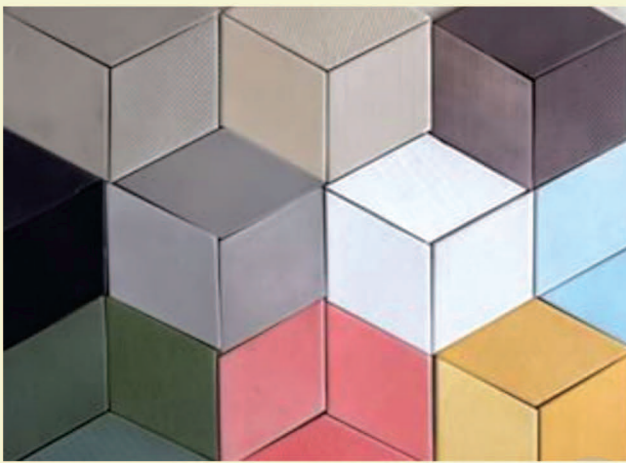

3D

ثلاثي الأبعاد

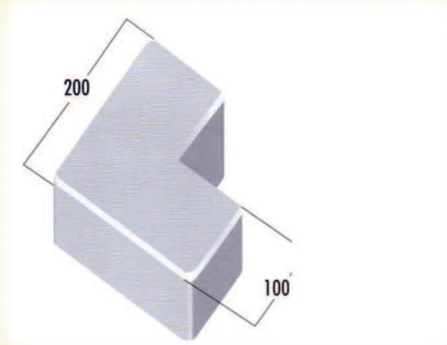

Dimension: 200 x 100 mm
Thickness: 60 mm
Weight: 3.50 kg
M²/Piece: 39Pcs

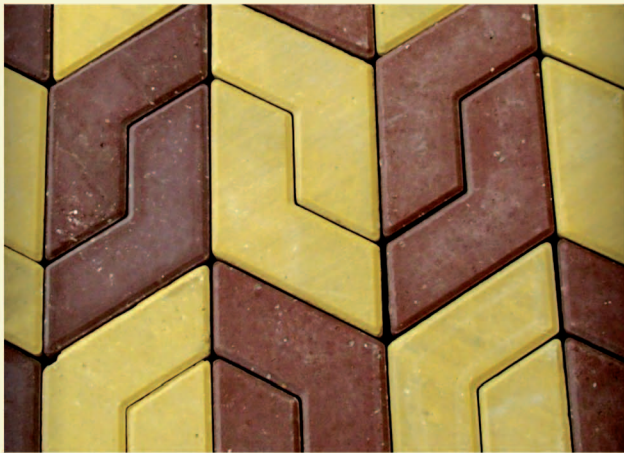
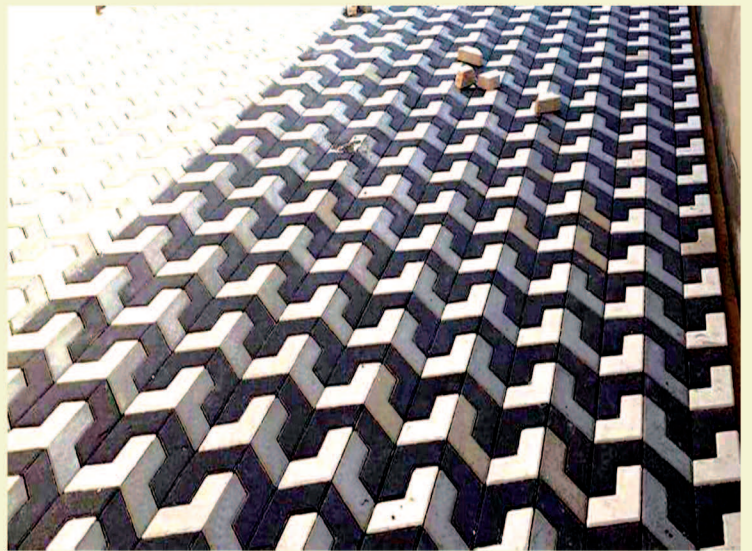
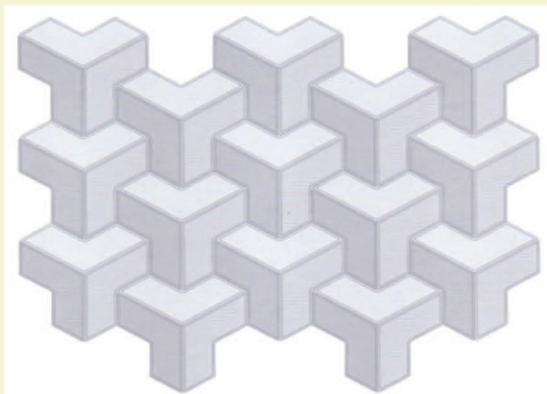

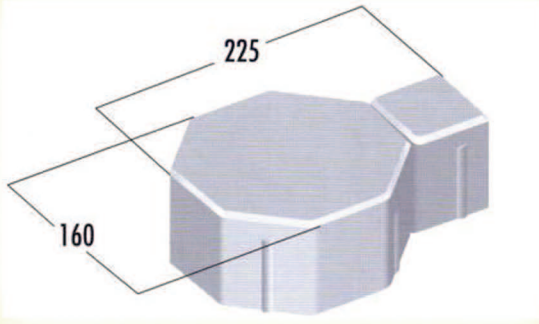

Dimension: 160 x 225 mm
Thickness: 60 mm
Weight: 3.70 kg
M² /Piece: 40 Pcs

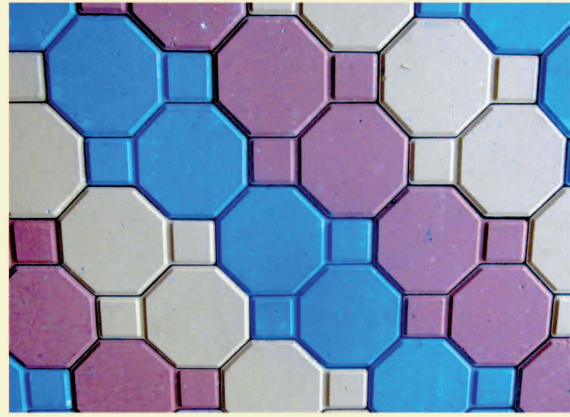
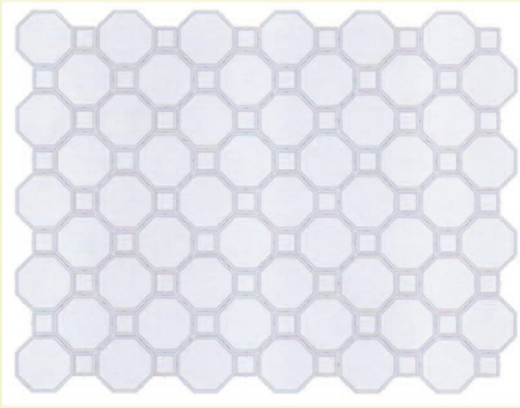

UNI

اليوني

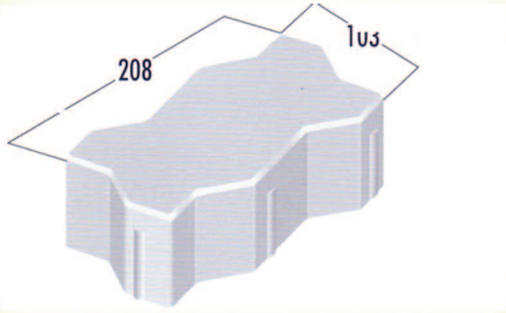

Dimension: 208 x 103 mm
Thickness: 60 mm
Weight: 3.3 kg
M²/Piece: 41 Pcs

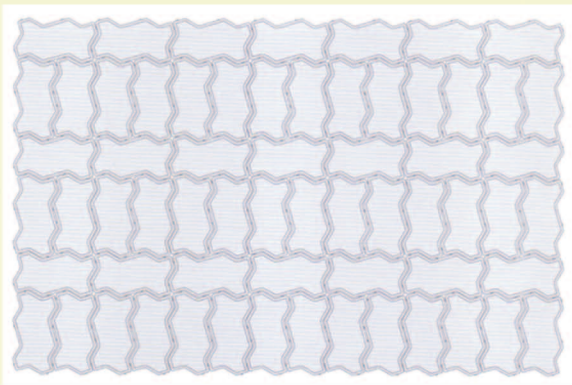

HEXAGONAL

البلاط السداسي

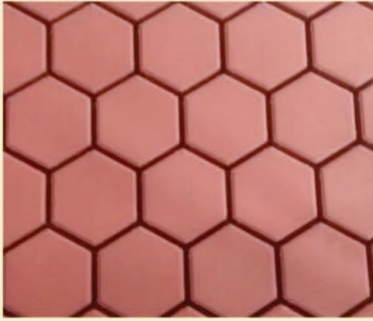

Dimension: 200 x 173.2 mm

Thickness: 60 - 80 mm

M²/Piece: 28.9 Pcs

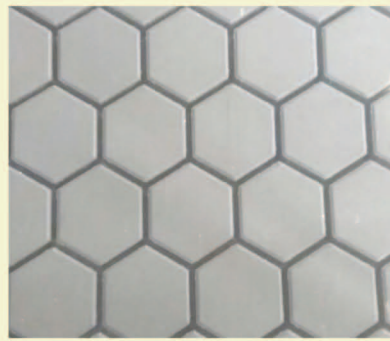

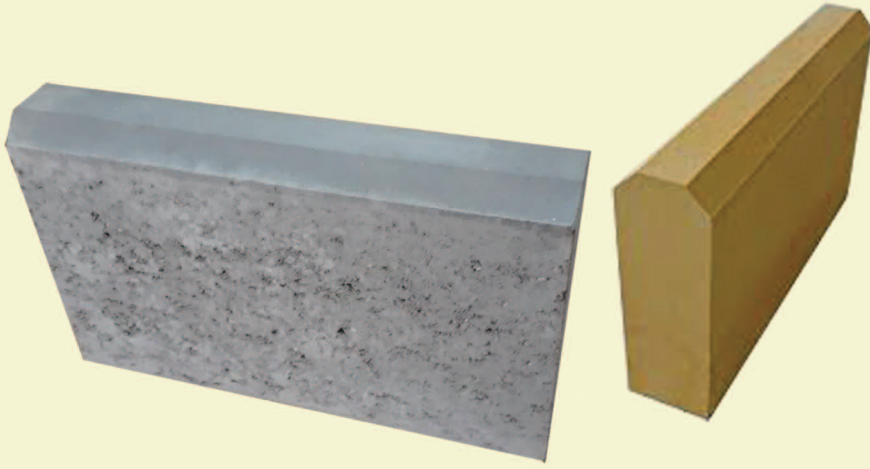

Dimension: 500 x 300 x 100 mm

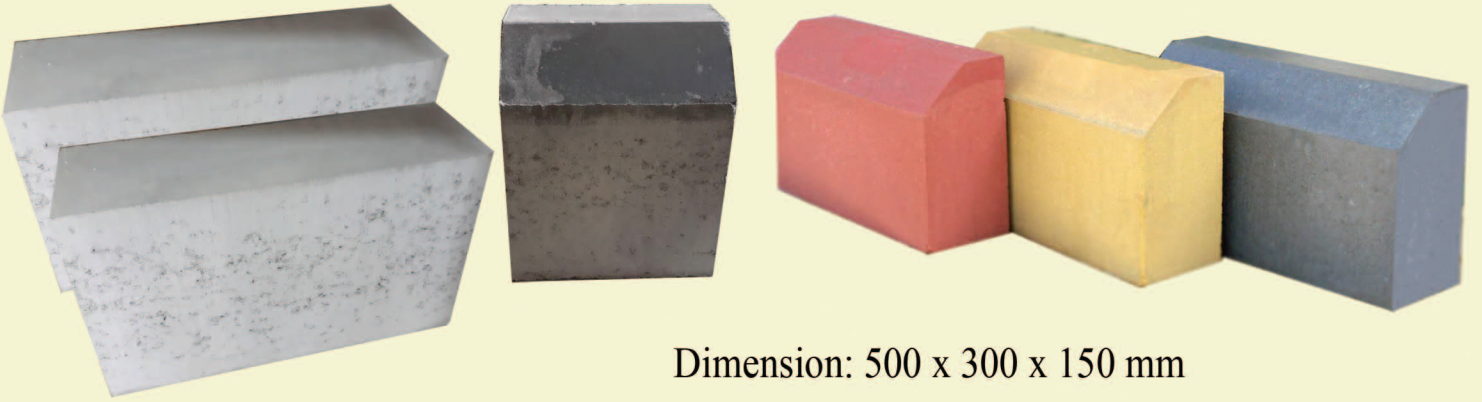

Dimension: 500 x 300 x 150 mm



ANGLE
2(500 x 300 x 150 mm)



ANGLE SMALL
2(250 x 300 x 100 mm)

Tiles / البلاط

Dimension: 600 x 600 mm
500 x 500 mm
400 x 400 mm

مقاس:

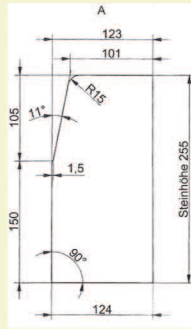

Curbstones / البلدورات

Dimension: 91.4 x 150 x 300 mm
91.4 x 150 x 250 mm
91.4 x 12.4 x 300 mm
91.4 x 12.4 x 250 mm

مقاس:



TILES

بلاط أرصفة

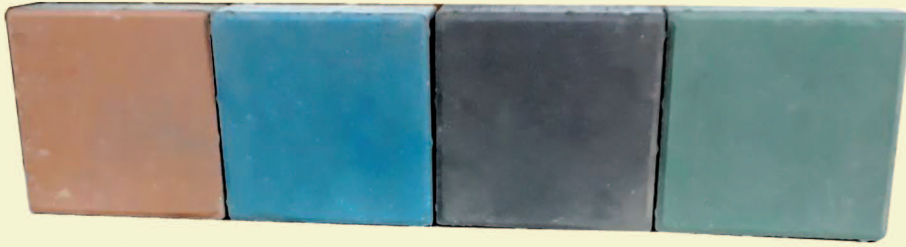

Dimension: 200 x 200 x 60 mm



Dimension: 400 x 400 x 60 mm
400 x 400 x 40 mm

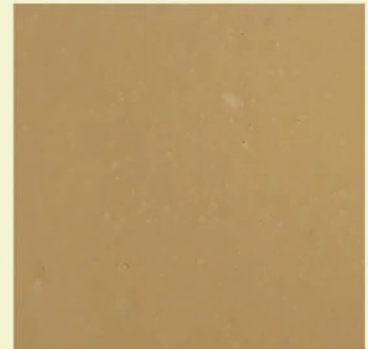

Dimension: 500 x 500 x 60 mm

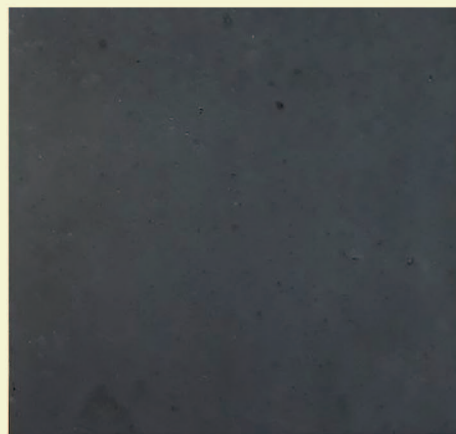

Dimension: 600 x 600 x 40 mm
600 x 600 x 60 mm

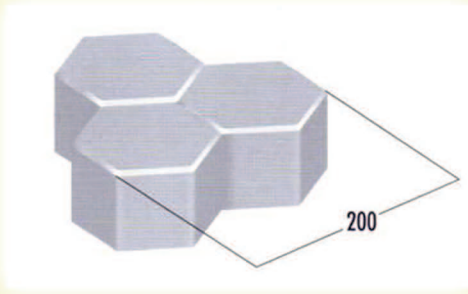

Dimension: 200 X 200 mm
Thickness: 60 mm
Weight: 3.40 kg
M²/Piece: 38 Pcs

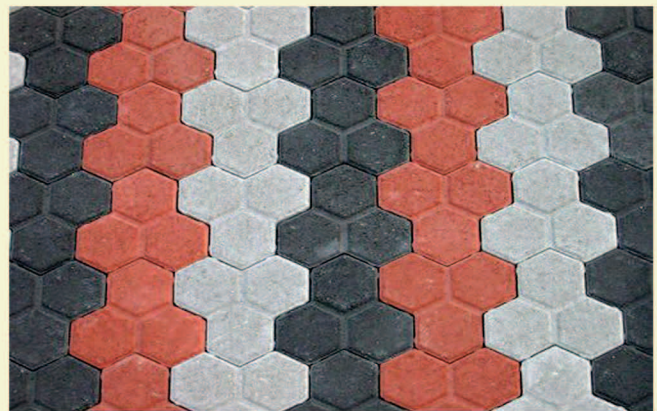
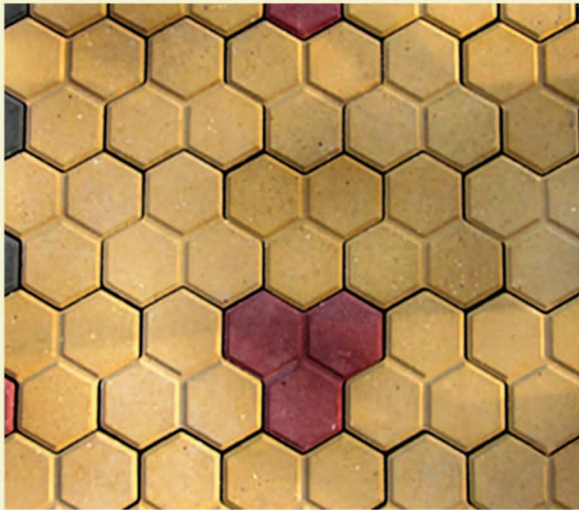
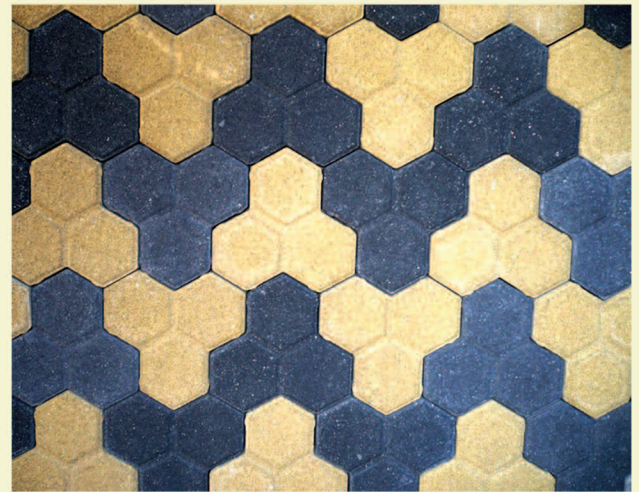
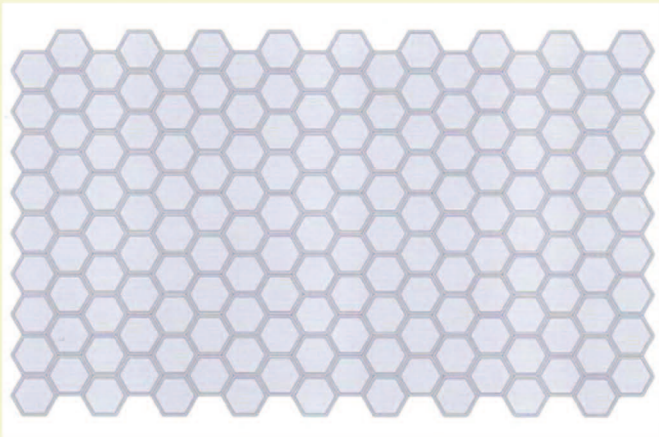

HOLLAND

هولاند

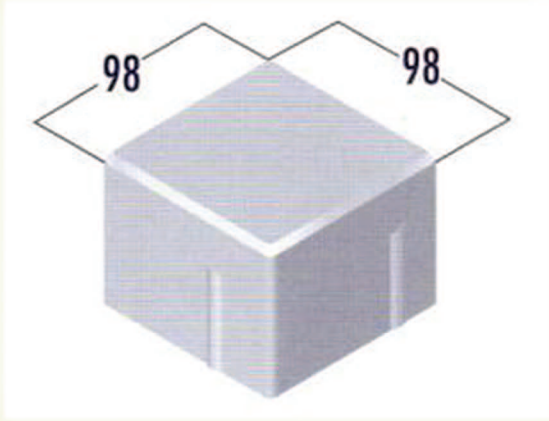

Dimension: 100 x 100 mm
Thickness: 60-80 mm
Weight: 1.35 -1.8 kg
M²/Piece: 100 Pcs

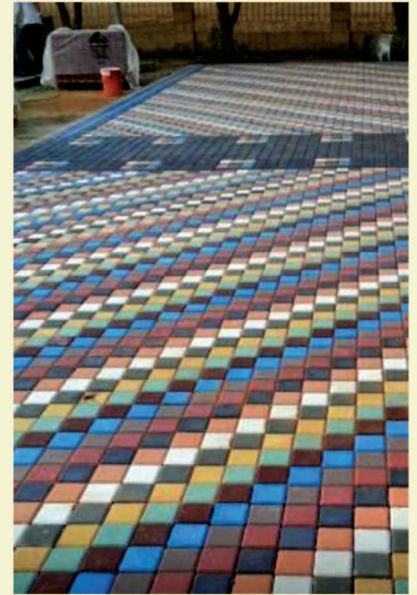

Multi Sizes & Colors

مختلف المقاسات والألوان

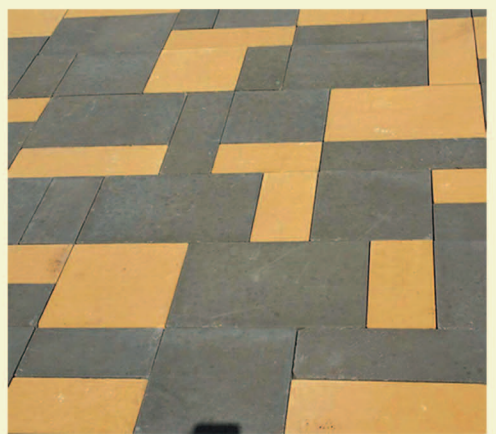
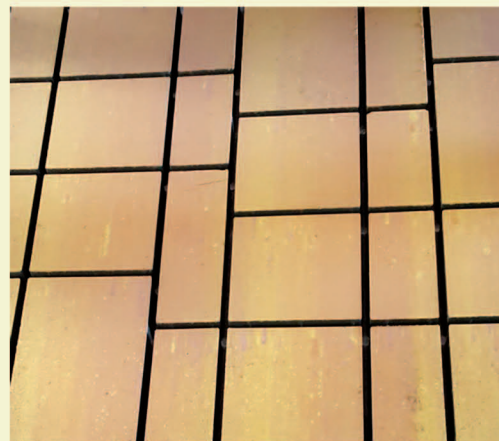
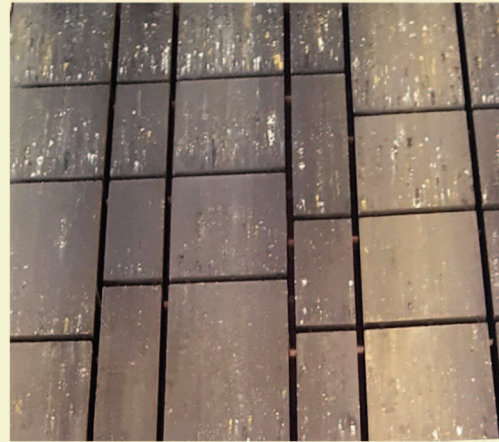
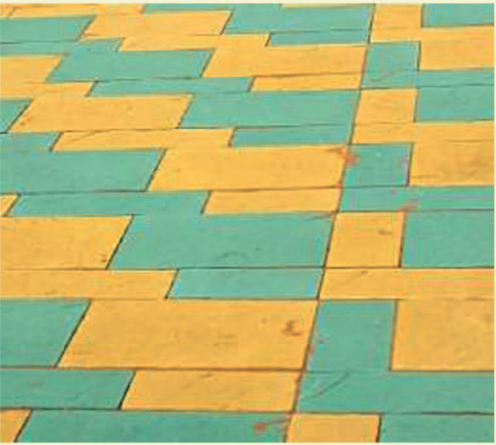

QUALITY CONTROL

مراقبة الجودة

We have a laboratory equipped with modern equipment and team of specialized workers to ensure good quality.

لدينا مختبر مزود بأجهزة حديثة وفريق عمل متخصص لضمان الجودة.

Our products stands high on verge of all quality so that they can easily withstand the local and national competition .

منتجاتنا تقف في قمة المنافسة على مستوى المنطقة او مستوى المملكة.

Our products are continuously tested and retested for their properties.

تخضع منتجاتنا بصورة مستمرة للاختبار وإعادة الاختبار لتأكيد خصائصها .

Our focus on quality is evident in our product range and performance.

تركيزنا على الجودة يتضح في جودة منتجاتنا وادائنا.

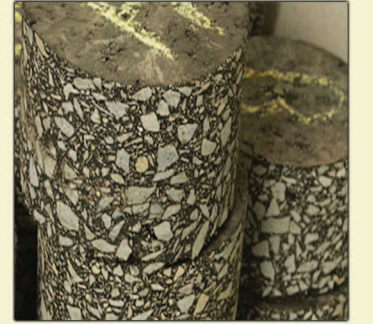
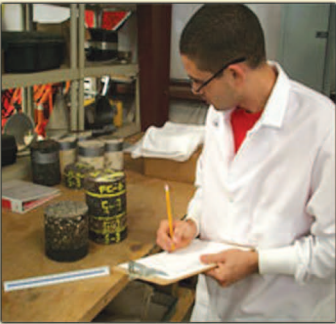
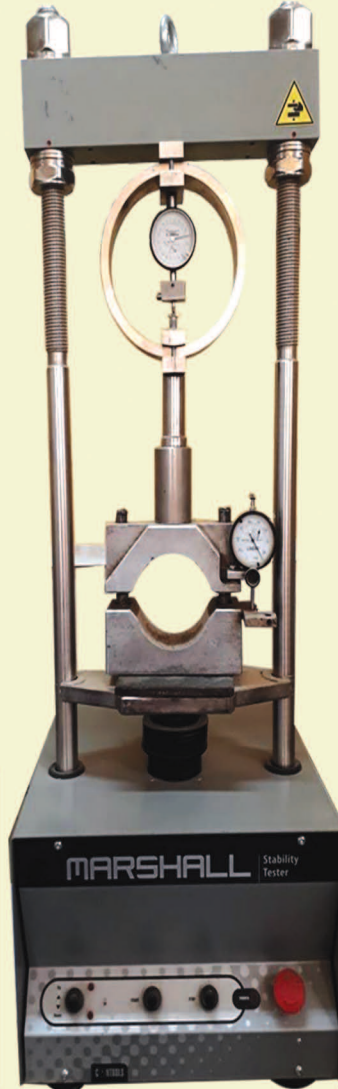
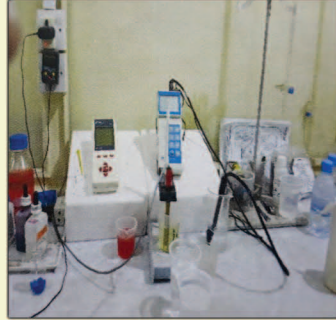
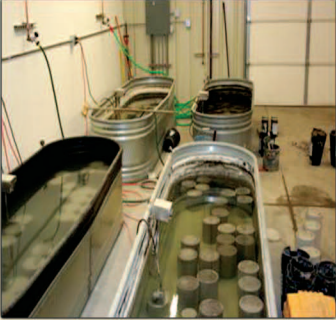

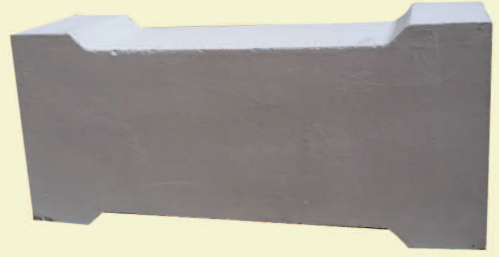

Hollow Core

الأسقف الجاهزة

كفاءة وجودة عالية للخرسانة مع سرعة التركيب.

يمكن بدء أعمال التشطيب فور التركيب.

أقل تكلفة من صب الأسقف بالطريقة العادية.

مرونة في التصميمات.

توفير المال والوقت والجهد.

High quality concrete and reduction in construction period.

Finishing works can be started immediately after installation.

Substantial saving in labor and machinery.

Flexibility in designs.

Saving money and time.



3D Panels

ألواح ثلاثية الأبعاد

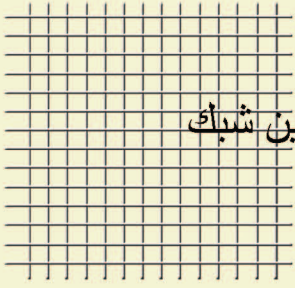

- 1 طبقة خرسانية 5سم
- 2 ألواح بوليستيرين مسلحة بطبقتين شبك
- 3 طبقة خرسانية

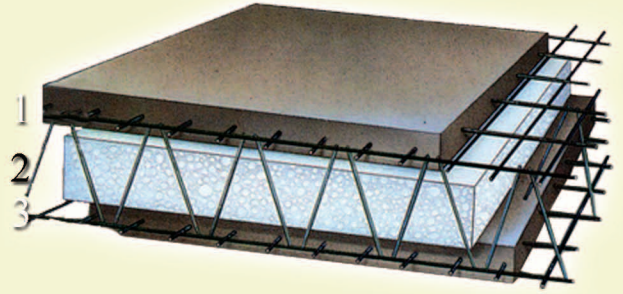

المزايا:-

عازلة للحرارة والصوت وتوفير للطاقة بنسبة 70%

سرعة في إنهاء المباني مع تقليل التكاليف بنسبة 20%

خفيفة الوزن مع قوة وأمان ضد الزلازل

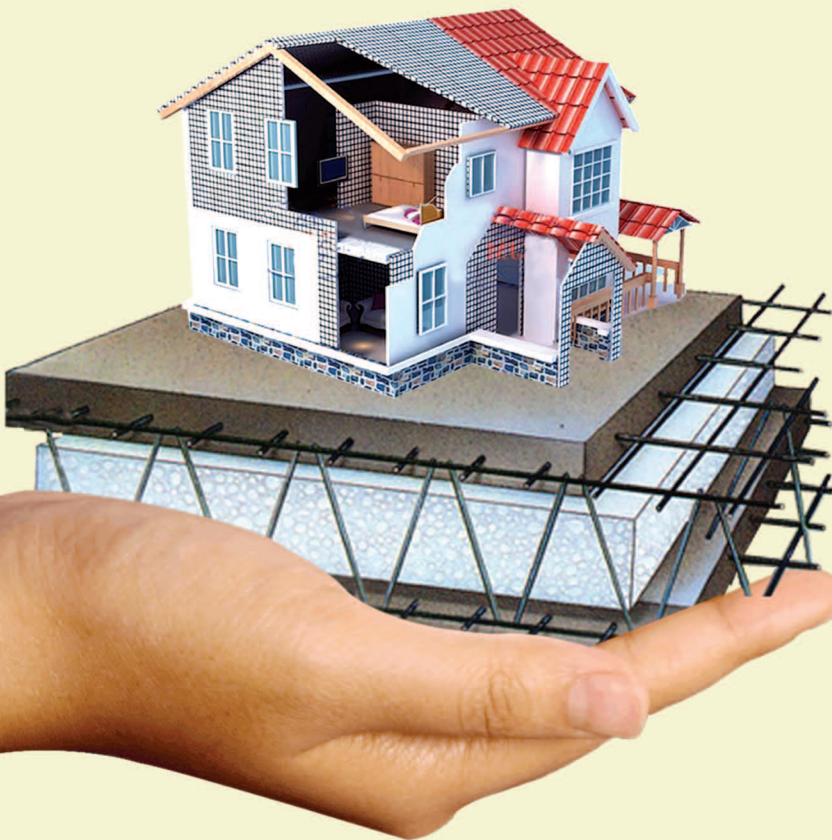
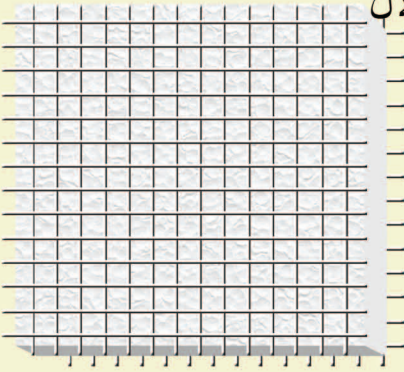

BLOCKS

البلوك



Hollow Block

Dimension: 20 x 20 x 40 cm

:15 x 20 x 40 cm

:10 x 20 x 40 cm

المقاس

البلوك العادي



Liner Block

Dimension: 20 x 20 x 40 cm

:15 x 20 x 40 cm

:10 x 20 x 40 cm

المقاس

البلوك المحرز



Solid Block & Half Solid Block

Dimension: 20 x 20 x 40 cm

:15 x 20 x 40 cm

:10 x 20 x 40 cm

:10 x 10 x 20 cm

البلوك المختوم



Block Hurdy

المقاس

البلوك الهوردي

ينتج من البحص البركاني الطبيعي ذو التجاويف الداخلية الخفيفة الوزن وعازلة للحرارة والصوت

يقل وزنه عن البلوك العادي بنسبة

التوصيل الحراري

درجة إنخفاض الضجيج دي بي

مقاوم للإحتراق لمدة لاتقل عن ثلاث ساعات.

متوفر بجميع المقاسات.

يوجد بلوك بوزلاني معزول بالبولسترين.

The bozlan block is produced from volcanic gravels with light interval cavities isolating sound and heat.

The weight of this type of block is less than normal block with 40%. It is stronger than the normal block.

- Thermal conductivity is 0.14 w/(m-k).
- Noise reduction level degree is 3-6 DB.
- Fire rating resistance at least 3 Hours.
- All sizes are available.
- Bozlani block isolated with polystyrene is available.

Hollow Block

Dimension: 20 x 20 x 40 cm

15 x 20 x 40 cm

10 x 20 x 40 cm



AL-FAHD.CO

TRADING INDUSTRIAES & CONTRACTING



9001:2015



المملكة العربية السعودية-عنيزة-

KINGDOM OF SAUDI ARABIA-ONAIZAH-P.O.BOX.354 (51911) TEL: 016 3659999 - FAX: 016 3656222

المملكة العربية السعودية-الرياض-

KINGDOM OF SAUDI ARABIA-RIYADH-P.O.BOX.(11630) (104585) TEL: 0112749999 - FAX: 0112142977

www.alfahd.com production@alfahd.com



THE CERTIFICATION

INTERNATIONAL

CERTIFICATION OF REGISTRATION

This is to certify that
Quality Management Systems
of

AL-FAHD CO. FOR TRADING, INDUSTRIES AND CONTRACTING

P.O. Box 354, Onaizah (51911), Al-Qassim, Saudi Arabia.

Has been assessed and found to meet the requirements of:

ISO 9001:2015

The certificate is valid for the following scope of operation:

**Ready-mixed concrete industry, block, interlocks, Curbs, Bishop Ready,
structural panels, asphalt mixes and products breaker.**

Certificate No. Q-0122

Original Issue Date: 15/11/2016 Issue Date: 19/10/2017 Valid Till: 14/11/2019

1st Surv. Done on : 16/10/2017

2nd Surv. Due Before: 07/11/2018

*After successful completion of surveillance audit, new certificate shall be issued

In the course of validity of the present certificate client management system must permanently satisfy the requirements of the International Regulations. The fulfillment of these regulations will be regularly controlled by The Certification International.



Director

The Certification International

Website: www.thecertification.org Email: info@thecertification.org

Accreditation by United Accreditation Foundation

3510, Colmar, Norfolk 23509, VA, United States of America (USA)

To check certification status: <http://uafaccreditation.org/list-organisation-certified-uaf-accredited-certification-bodies>

